

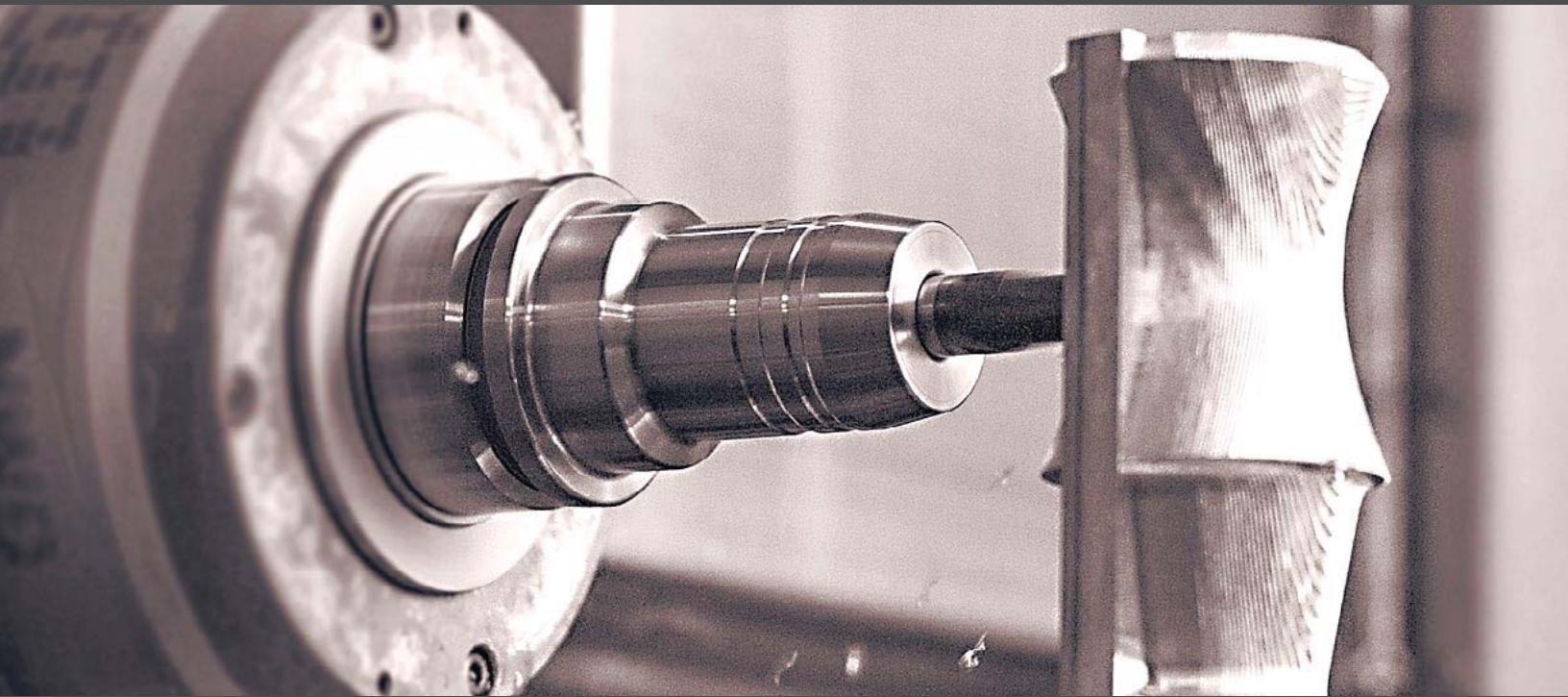

High-Precision HSK Toolholders

Expanded product line for all types of applications.

Techniks is your #1 source for HSK toolholders



Holder Type	Spindle Types	TKS Certified	Coolant-thru	Slim Nose	Extended
ER Collet Chucks	HSK32A, 40A, 50A, 63A, 100A, 32E, 40E, 50E, 63E, 50F, 63F	✓	✓	✓	✓
ShrinkFIT	HSK40E, 50E, 63A, 63F, 100A	✓	✓	✓	✓
SFS12 Modular ShrinkFIT System	HSK40E, 63A, 63F, 100A	✓		✓	✓
Hydraulics	HSK63A, 63A-HMC, 63F, 100A	✓	✓	✓	✓
End Mill Holders	HSK63A, 63F, 100A	✓	✓	✓	✓
Face Mill Arbors	HSK63A, 63F, 100A	✓	✓		✓
SlimFIT	HSK63A	✓		✓	✓
Tapping Chucks	HSK40A, 50A, 63A, 100A	✓	✓	✓	✓
Milling Chucks	HSK63A, 100A	✓	✓		

High Precision HSK ER Toolholders



HSK 63A



HSK 100A

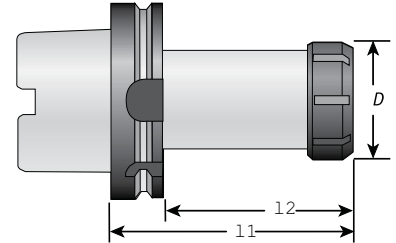

HSK32A, 40A, 50A, Toolholders

Part No.	Description	I1	I2	D	Wrench
31278	HSK32A x ER20 - 80mm, slotted nut	80mm	60mm	34mm	04614
31284	HSK32A x ER25 - 80mm, mini nut	80mm	60mm	35mm	04624
31374	HSK40A x ER11 - 80mm, mini nut	80mm	60mm	16mm	04621
31376	HSK40A x ER16 - 80mm, hex nut	80mm	54mm	28mm	04609
31384	HSK40A x ER25 - 80mm, slotted nut	80mm	60mm	35mm	04624
31385	HSK40A x ER32 - 80mm, slotted nut	80mm	60mm	50mm	04616
31420	HSK50A x ER32 - 100mm, slotted nut	100mm	74mm	50mm	04616

HSK63A Toolholders

NEW

NEW

NEW

NEW

Part No.	Description	I1	I2	D	Wrench
31430	HSK63A x ER11 - 100mm, hex nut	100mm	74mm	16mm	04621
31432	HSK63A x ER16 - 80mm, hex nut	80mm	54mm	28mm	04609
31434	HSK63A x ER16 - 100mm, hex nut	100mm	74mm	28mm	04609
31438	HSK63A x ER16 - 160mm, hex nut	160mm	134mm	28mm	04609
31440	HSK63A x ER20 - 80mm, hex nut	80mm	54mm	34mm	04610
31446	HSK63A x ER20 - 160mm, hex nut	160mm	134mm	34mm	04610
31462	HSK63A x ER32 - 100mm, slotted nut	100mm	74mm	50mm	04616
31466	HSK63A x ER32 - 160mm, slotted nut	160mm	134mm	50mm	04616
31466-8T	HSK63A x ER32 - 8", tapered style, slot nut	8"	134mm	50mm	04616
31468	HSK63A x ER40 - 80mm, slotted nut	80mm	54mm	63mm	04617
31472	HSK63A x ER40 - 120mm, slotted nut	120mm	94mm	63mm	04617
31476-8T	HSK63A x ER40 - 8", tapered style, slot nut	8"	94mm	63mm	04617

(Part Numbers with a -8T suffix indicate tapered style holder. Taper improves rigidity at extended lengths)

HSK100A Toolholders

Part No.	Description	I1	I2	D	Wrench
31484	HSK100A x ER16 - 100mm, hex nut	100mm	74mm	28mm	04609
31486	HSK100A x ER16 - 160mm, hex nut	160mm	134mm	28mm	04609
31490	HSK100A X ER20 - 100mm, hex nut	100mm	74mm	34mm	04610
31492	HSK100A X ER20 - 160mm, hex nut	160mm	134mm	34mm	04610
31494	HSK100A X ER25 - 100mm, slotted nut	100mm	74mm	35mm	04624
31498	HSK100A x ER32 - 100mm, slotted nut	100mm	71mm	50mm	04616
31503	HSK100A x ER32 - 160mm, slotted nut	160mm	134mm	50mm	04616
31506	HSK100A x ER40 - 120mm, slotted nut	120mm	91mm	63mm	04617

HSK Toolholders for CNC Routers



Techniks Certified for accuracy and balance

Features

- *Balanced to 25,000 RPM at G2.5*
- *T.I.R. 0.0001" measured from taper to collet pocket*
- *PowerCOAT nut included for 75% more clamping power*

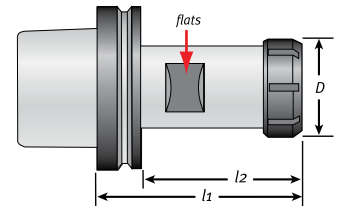

HSK32E, 40E, 50E, 63E Toolholders for HSK E Type Spindle

Part No.	Description	l1	l2	D	Nut	Set Screw	Wrench	Flats
31374-60-E	HSK32E x ER25 - 60mm, slotted nut	60mm	27mm	42mm	46125	16089	04615	22mm
31376-E	HSK40E x ER16 - 65mm, slotted nut	65mm	45mm	32mm	46116	16083	04613	24mm
31383-E	HSK40E x ER25 - 75mm, slotted nut	75mm	55mm	42mm	46125	16089	04615	27mm
31386-E	HSK40E x ER32 - 100mm, slotted nut	100mm	80mm	50mm	46132	16089	04616	35mm
31402-E	HSK50E x ER16 - 80mm, slotted nut	80mm	60mm	28mm	46116	16083	04613	27mm
31419-E	HSK50E x ER32 - 85mm, slotted nut	85mm	59mm	50mm	46132	16089	04616	36mm
31456-E	HSK63E x ER32 - 90mm, slotted nut	90mm	64mm	50mm	46132	16089	04616	36mm
31472-E	HSK63E x ER40 - 120mm, slotted nut	120mm	94mm	63mm	46140	16091	04617	46mm
50001	HSK63E x ER40 - 75mm, slotted nut	75mm	49mm	63mm	46140	16091	04617	46mm



Techniks Certified for accuracy and balance

Features

- *Balanced to 25,000 RPM at G2.5*
- *T.I.R. 0.0001" measured from taper to collet pocket*
- *PowerCOAT nut included for 75% more clamping power*

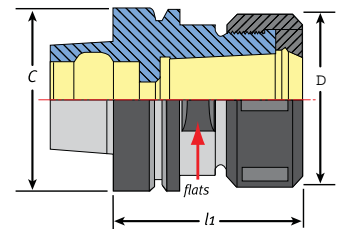

HSK50F, 63F Toolholders for CNC Routers

Part No.	Description	l1	D	Nut	Wrench	Flats
31419-F	HSK50F x ER32 - 80mm, slotted nut	80mm	50mm	46132	04616	36mm
103.123.11.100	HSK63F x ER11 - 100mm	100mm	16mm	23111	04621	-
31431-F	HSK63F x ER16 - 60mm, slotted nut	60mm	32mm	46116	04613	26mm
31434-F	HSK63F x ER16 - 100mm, slotted nut	100mm	32mm	46116	04613	26mm
30000	HSK63F x ER32 - 70mm, slotted nut	70mm	50mm	46132	04616	36mm
30001	HSK63F x ER40 - 75mm, slotted nut	75mm	63mm	46140	04617	46mm
30001-L	HSK63F x ER40 - 75mm, left-hand thread	75mm	63mm	46140-L	04617	46mm
30001-Solid	HSK63F x ER40 - 75mm, No thru hole	75mm	63mm	46140	04617	46mm
30002	HSK63F x ER40 - 90mm, slotted nut	90mm	63mm	46140	04617	46mm
30003	HSK63F x ER40 - 115mm, slotted nut	115mm	63mm	46140	04617	46mm
30005	HSK63F x ER40 - 125mm, slotted nut	125mm	63mm	46140	04617	46mm
31025F	HSK63 F x SY0Z 25 - 80mm, slotted nut	80mm	60mm	83632	03691	38mm

HSK40E, 50E Precision ShrinkFIT Holders



Features

- Maximum T.I.R. only 0.0001"
- Balanced 25,000 RPM at G2.5
- Coolant-thru set screw comes installed

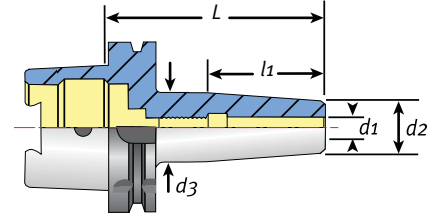

HSK40E Inch Size ShrinkFIT Holders

Part No.	Description	d1	d2	d3	L	l2	thread	coolant screw
39001-E	HSK40E x 1/8" I.D. - 3.54"	1/8"	.36"	.47"	3.54"	.79"	-	16081C-20
39002-E	HSK40E x 3/16" I.D. - 3.54"	3/16"	.63"	.71"	3.54"	.79"	-	16081C-20
39004-E	HSK40E x 1/4" I.D. - 3.54"	1/4"	.71"	1.06"	3.54"	1.42"	M5 x 0.8P	16080C-20
39006-E	HSK40E x 5/16" I.D. - 3.54"	5/16"	.83"	1.06"	3.54"	1.42"	M6 x 1.0P	16081C-20
39008-E	HSK40E x 3/8" I.D. - 3.54"	3/8"	.94"	1.26"	3.54"	1.65"	M8 x 1.25P	16082C-20

HSK40E Metric Size ShrinkFIT Holders

Part No.	Description	d1	d2	d3	L	l2	thread	coolant screw
39082-E	HSK40E x 3mm I.D. - 80mm	3mm	9mm	18mm	80mm	18mm	-	16081C-20
39084-E	HSK40E x 4mm I.D. - 80mm	4mm	10mm	22mm	80mm	20mm	-	16081C-20
39088-E	HSK40E x 6mm I.D. - 80mm	6mm	21mm	27mm	80mm	36mm	M5 x 0.8P	16080C-20
39090-E	HSK40E x 8mm I.D. - 80mm	8mm	21mm	27mm	80mm	36mm	M6 x 1.0P	16081C-20
39092-E	HSK40E x 10mm I.D. - 80mm	10mm	24mm	32mm	85mm	42mm	M8 x 1.25P	16082C-20



SlimLINE Features

- Smaller nose diameter (d2)
- Maximum T.I.R. only 0.0001"
- Balanced 25,000 RPM at G2.5

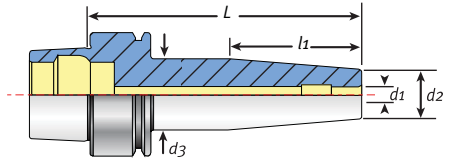

HSK40E SlimLINE ShrinkFIT Holders

Part No.	Description	d1	d2	d3	L	l2	thread	coolant screw
99528	HSK40E x 1/8" I.D. - 2.36" SlimLINE	1/8"	.36"	.63"	2.36"	.78"	M6 x 1.0P	16081C-20
99538	HSK40E x 3/16" I.D. - 2.36" SlimLINE	3/16"	.43"	.69"	2.36"	.78"	M6 x 1.0P	16081C-20
99548	HSK40E x 1/4" I.D. - 2.36" SlimLINE	1/4"	.47"	.81"	2.36"	1.42"	M5 x 0.8P	16080C-20
99568	HSK40E x 3/8" I.D. - 2.36" SlimLINE	3/8"	.63"	.94"	2.36"	1.65"	M8 x 1.25P	16082C-20
99588	HSK40E x 1/2" I.D. - 2.36" SlimLINE	1/2"	.71"	1.06"	2.36"	1.85"	M10 x 1.5P	16083C-20

HSK50E ShrinkFIT Holders

Part No.	Description	d1	d2	d3	L	l2	thread	coolant screw
39014-E	HSK50E x 1/8" I.D. - 3.15"	1/8"	.36"	.87"	3.15"	.79"	M6 x 1.0P	16081C-20
39016-E	HSK50E x 3/16" I.D. - 3.54"	3/16"	.43"	.87"	3.54"	.79"	M6 x 1.0P	16081C-20
39018-E	HSK50E x 1/4" I.D. - 3.54"	1/4"	.71"	1.06"	3.54"	1.42"	M5 x 0.8P	16080C-20
39020-E	HSK50E x 5/16" I.D. - 3.54"	5/16"	.83"	1.06"	3.54"	1.42"	M6 x 1.0P	16081C-20
39022-E	HSK50E x 3/8" I.D. - 3.54"	3/8"	.94"	1.26"	3.54"	1.65"	M8 x 1.25P	16082C-20
39024-E	HSK50E x 1/2" I.D. - 3.54"	1/2"	1.10"	1.34"	3.54"	1.85"	M10 x 1.5P	16083C-20
39025-E	HSK50E x 5/8" I.D. - 3.54"	5/8"	1.06"	1.34"	3.54"	.97"	M12 x 1.75P	16085C-20

HSK63A Precision ShrinkFIT Holders



Techniks Certified for accuracy and balance

Features

- Maximum T.I.R. only 0.0001"
- Balanced 25,000 RPM at G2.5
- Coolant-thru set screw installed

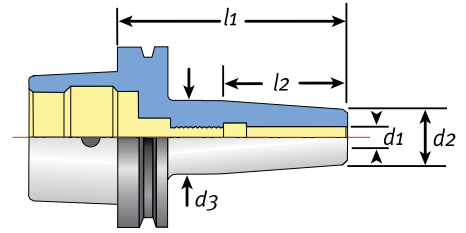

HSK63A Inch Size ShrinkFIT Toolholders

Part No.	Description	d1	d2	d3	L	l1	thread	coolant screw
93115	HSK63A x 1/4" I.D. - 3.15"	1/4"	.83"	1.06"	3.15"	1.42"	M5 x 0.8P	16082C-20
93116	HSK63A x 5/16" I.D. - 3.15"	5/16"	.83"	1.06"	3.15"	1.42"	M6 x 1.0P	16082C-20
93117	HSK63A x 3/8" I.D. - 3.35"	3/8"	.94"	1.26"	3.35"	1.65"	M8 x 1.25P	16082C-20
93118	HSK63A x 7/16" I.D. - 3.54"	7/16"	.94"	1.26"	3.54"	1.85"	M8 x 1.25P	16082C-20
93119	HSK63A x 1/2" I.D. - 3.54"	1/2"	.94"	1.26"	3.54"	1.85"	M10 x 1.5P	16083C-20
93120	HSK63A x 9/16" I.D. - 3.54"	9/16"	1.06"	1.34"	3.54"	1.85"	M10 x 1.5P	16083C-20
93121	HSK63A x 5/8" I.D. - 3.74"	5/8"	1.06"	1.34"	3.74"	1.97"	M12 x 1.75P	16085C-20
93124	HSK63A x 3/4" I.D. - 3.94"	3/4"	1.30"	1.65"	3.94"	2.05"	M16 x 2.0P	16089C-20
93126	HSK63A x 1.0" I.D. - 4.53"	1.0"	1.73"	2.05"	4.53"	2.28"	M20 x 2.0P	16091C-20
93128	HSK63A x 1-1/4" I.D. - 4.72"	1-1/4"	1.73"	2.09"	4.72"	2.28"	M20 x 2.0P	16091C-20

HSK63A Extended Length ShrinkFIT Toolholders

Part No.	Description	d1	d2	d3	L	l1	thread	coolant screw
93130	HSK63A x 3/8" I.D. - 6.3"	3/8"	.94"	1.26"	6.3"	1.65"	M8 x 1.25P	16082C-20
93135	HSK63A x 1/2" I.D. - 6.3"	1/2"	.94"	1.10"	6.3"	1.85"	M10 x 1.5P	16083C-20
93140	HSK63A x 3/4" I.D. - 6.3"	3/4"	1.42"	1.65"	6.3"	2.05"	M16 x 2.0P	16089C-20
93145	HSK63A x 1.0" I.D. - 6.3"	1.0"	1.73"	2.09"	6.3"	2.28"	M20 x 2.0P	16091C-20



SlimLINE Features

- Smaller nose diameter (d2)
- Maximum T.I.R. only 0.0001"
- Balanced 25,000 RPM at G2.5

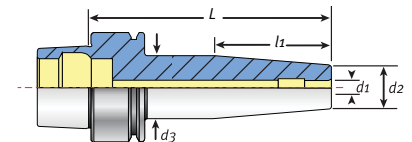

HSK63A SlimLINE ShrinkFIT Holders

Part No.	Description	d1	d2	d3	L	l1	thread	coolant screw
73528	HSK63A x 1/8" I.D. - 3.15" SlimLINE	1/8"	.35"	.63"	3.15"	.78"	M6x1.0P	16081C-20
73538	HSK63A x 3/16" I.D. - 3.15" SlimLINE	3/16"	.43"	.69"	3.15"	.78"	M6x1.0P	16081C-20
73548	HSK63A x 1/4" I.D. - 3.15" SlimLINE	1/4"	.47"	.81"	3.15"	1.42"	M5x0.8P	16080C-20
73568	HSK63A x 3/8" I.D. - 3.15" SlimLINE	3/8"	.63"	.94"	3.15"	1.65"	M8x1.25P	16082C-20
73588	HSK63A x 1/2" I.D. - 3.15" SlimLINE	1/2"	.71"	1.06"	3.15"	1.85"	M10x1.5P	16083C-20

HSK63A/F CoolBLAST ShrinkFIT Toolholders

HSK63A Metric Size ShrinkFIT Toolholders

Part No.	Description	d1	d2	d3	L	l1	thread	coolant screw
39132	HSK63A x 4mm I.D. - 80mm	4mm	10mm	22mm	80mm	20mm	M6 x 1.0P	16082C-20
39134	HSK63A x 5mm I.D. - 80mm	5mm	16mm	22mm	80mm	20mm	M6 x 1.0P	16082C-20
39136	HSK63A x 6mm I.D. - 80mm	6mm	21mm	27mm	80mm	36mm	M5 x 0.8P	16082C-20
39138	HSK63A x 8mm I.D. - 80mm	8mm	21mm	27mm	80mm	36mm	M6 x 1.0P	16082C-20
39140	HSK63A x 10mm I.D. - 85mm	10mm	24mm	32mm	85mm	42mm	M8 x 1.25P	16082C-20
39142	HSK63A x 12mm I.D. - 90mm	12mm	24mm	32mm	90mm	47mm	M10 x 1.5P	16083C-20
39144	HSK63A x 14mm I.D. - 90mm	14mm	27mm	34mm	90mm	47mm	M10 x 1.5P	16083C-20
39146	HSK63A x 16mm I.D. - 95mm	16mm	27mm	34mm	95mm	50mm	M12 x 1.75P	16085C-20
39148	HSK63A x 18mm I.D. - 95mm	18mm	33mm	42mm	95mm	50mm	M12 x 1.75P	16085C-20
39150	HSK63A x 20mm I.D. - 100mm	20mm	33mm	42mm	100mm	52mm	M16 x 2.0P	16089C-20
39152	HSK63A x 25mm I.D. - 115mm	25mm	44mm	53mm	115mm	58mm	M20 x 2.0P	16091C-20
39154	HSK63A x 32mm I.D. - 120mm	32mm	44mm	53mm	120mm	58mm	M20 x 2.0P	16091C-20

HSK63A Inch Size CoolBLAST ShrinkFIT Toolholders

Part No.	Description	d1	d2	d3	L	l1	thread	coolant screw
93113B	HSK63A x 1/8" I.D. - 3.15" with CoolBLAST	1/8"	.63"	.87"	3.15"	.79"	M6x1.0P	16081C-20
93114B	HSK63A x 3/16" I.D. - 3.15" with CoolBLAST	3/16"	.63"	.87"	3.15"	.79"	M6 x 1.0P	16082C-20
93115B	HSK63A x 1/4" I.D. - 3.15" with CoolBLAST	1/4"	.83"	1.06"	3.15"	1.42"	M5 x 0.8P	16082C-20
93115-6B	HSK63A x 1/4" I.D. - 6" with CoolBLAST	1/4"	.83"	1.06"	6"	1.42"	M5 x 0.8P	16082C-20
93117B	HSK63A x 3/8" I.D. - 3.35" with CoolBLAST	3/8"	.94"	1.26"	3.35"	1.65"	M8 x 1.25P	16082C-20
93117-6B	HSK63A x 3/8" I.D. - 6" with CoolBLAST	3/8"	.94"	1.26"	6"	1.65"	M8 x 1.25P	16082C-20
93119B	HSK63A x 1/2" I.D. - 3.54" with CoolBLAST	1/2"	1.110"	1.34"	3.54"	1.85"	M10 x 1.5P	16083C-20
93119-6B	HSK63A x 1/2" I.D. - 6" with CoolBLAST	1/2"	1.110"	1.34"	6"	1.85"	M10 x 1.5P	16083C-20
93121B	HSK63A x 5/8" I.D. - 3.74" with CoolBLAST	5/8"	1.06"	1.34"	3.74"	1.97"	M12 x 1.75P	16085C-20
93121-6B	HSK63A x 5/8" I.D. - 6" with CoolBLAST	5/8"	1.06"	1.34"	6"	1.97"	M12 x 1.75P	16085C-20
93124B	HSK63A x 3/4" I.D. - 3.94" with CoolBLAST	3/4"	1.30"	1.65"	3.94"	2.05"	M16 x 2.0P	16089C-20
93124-6B	HSK63A x 3/4" I.D. - 6" with CoolBLAST	3/4"	1.30"	1.65"	6"	2.05"	M16 x 2.0P	16089C-20
93126-6B	HSK63A x 1" I.D. - 6" with CoolBLAST	1"	1.42"	1.65"	6"	2.04"	M20 x 2.0P	16091C-20

HSK63F Inch ShrinkFIT Toolholders

Part No.	Description	d1	d2	d3	l1	l2	thread	coolant screw
71250	HSK63F x 1/4" I.D. - 3.15"	1/4"	.83"	1.06"	3.15"	1.42"	M5 x 0.8P	16080C-20
71312	HSK63F x 5/16" I.D. - 3.74"	5/16"	.79"	1.06"	3.74"	1.42"	M6 x 1.0P	16081C-20
71375	HSK63F x 3/8" I.D. - 3.74"	3/8"	.94"	1.26"	3.74"	1.65"	M8 x 1.25P	16082C-20
71500	HSK63F x 1/2" I.D. - 3.74"	1/2"	.94"	1.26"	3.74"	1.85"	M10 x 1.5P	16083C-20
71625	HSK63F x 5/8" x 3.74"	5/8"	1.06"	1.34"	3.74"	1.97"	M12 x 1.75P	16085C-20
71750	HSK63F x 3/4" I.D. - 3.94"	3/4"	1.42"	1.65"	3.94"	2.05"	M16 x 2.0P	16089C-20
71100	HSK63F x 1.0" I.D. - 4.53"	1"	1.42"	1.65"	4.53"	2.28"	M20 x 2.0P	16091C-20

HSK63F Metric ShrinkFIT Toolholders

Part No.	Description	d1	d2	d3	l1	l2	thread	coolant screw
71010	HSK63F x 20mm I.D. - 100mm	20mm	33mm	42mm	100mm	47mm	M16 x 2.0P	16089C-20
71011	HSK63F x 25mm I.D. - 115mm	25mm	44mm	53mm	115mm	58mm	M20 x 2.0P	16091C-20

HSK100A CoolBLAST ShrinkFIT Toolholders



Features

- Maximum T.I.R. only 0.0001"
- Balanced 25,000 RPM at G2.5
- Coolant-thru set screw installed

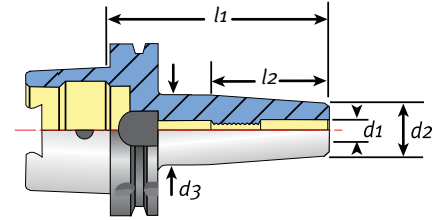

CoolBLAST coolant ports direct coolant on the tool path, even at high RPMs. No need to purchase coolant-thru cutting tools.

CoolBLAST features a 3° angle to better direct coolant on the cutting tool.

HSK100A ShrinkFIT Toolholders

Part No.	Description	d1	d2	d3	l1	l2	thread	coolant screw
39304	HSK100A x 1/8" I.D. - 90	1/8"	.35"	.87"	90	.79"	M6 x 1.0P	16081C-20
39306	HSK100A x 1/4" I.D. - 90	1/4"	.83"	1.06"	90	1.42"	M5 x 0.8P	16080C-20
NEW 39307	HSK 100A x 1/4" I.D. - 160	1/4"	.83"	1.06"	160	1.42"	M5 x 0.8P	16080C-20
39308	HSK100A x 5/16" I.D. - 85	5/16"	.79"	1.06"	85	1.42"	M6 x 1.0P	16081C-20
39310	HSK 100A x 3/8" I.D. - 90	3/8"	.94"	1.26"	90	1.65"	M8 x 1.25P	16082C-20
39310-6	HSK100A x 3/8" I.D. - 6"	3/8"	.94"	1.26"	6"	1.65"	M8 x 1.25P	16082C-20
NEW 39311	HSK 100A x 3/8" I.D. - 160	3/8"	.94"	1.26"	160	1.65"	M8 x 1.25P	16082C-20
39312	HSK100A x 7/16" I.D. - 95	7/16"	.94"	1.26"	95	1.85"	M10 x 1.5P	16083C-20
39314	HSK100A x 1/2" I.D. - 95	1/2"	1.10"	1.34"	95	1.85"	M10 x 1.5P	16083C-20
39315	HSK100A x 1/2" I.D. - 160	1/2"	1.10"	1.34"	160	1.85"	M10 x 1.5P	16083C-20
39318	HSK100A x 5/8" I.D. - 100	5/8"	1.06"	1.34"	100	1.97"	M12 x 1.75P	16085C-20
39319	HSK100A x 5/8" I.D. - 160	5/8"	1.26"	1.34"	160	1.97"	M12 x 1.75P	16085C-20
39320	HSK100A x 3/4" I.D. - 105	3/4"	1.42"	1.65"	105	2.04"	M16 x 2.0P	16089C-20
39321	HSK100A x 3/4" I.D. - 160	3/4"	1.42"	1.65"	160	2.04"	M16 x 2.0P	16089C-20
39324	HSK100A x 1.0" I.D. - 115	1.0"	1.81"	2.09"	115	2.28"	M20 x 2.0P	16091C-20
39325	HSK100A x 1.0" I.D. - 160	1.0"	1.81"	2.09"	160	2.28"	M20 x 2.0P	16091C-20
39326	HSK100A x 1-1/4" I.D. - 120	1-1/4"	1.81"	2.09"	120	2.28"	M20 x 2.0P	16091C-20
39327	HSK100A x 1-1/4" I.D. - 160	1-1/4"	1.81"	2.09"	160	2.28"	M20 x 2.0P	16091C-20

HSK100A ShrinkFIT CoolBLAST Toolholders

Part No.	Description	d1	d2	d3	l1	l2	thread
39306B	HSK 100A x 1/4" I.D. - 90 CoolBLAST	1/4"	.83"	1.06"	90	1.42"	M5 x 0.8P
39307B	HSK 100A x 1/4" I.D. - 160 CoolBLAST	1/4"	.83"	1.06"	160	1.42"	M5 x 0.8P
39310B	HSK 100A x 3/8" I.D. - 90 CoolBLAST	3/8"	.94"	1.26"	90	1.65"	M8 x 1.25P
39311B	HSK 100A x 3/8" I.D. - 160 CoolBLAST	3/8"	.94"	1.26"	160	1.65"	M8 x 1.25P
39314B	HSK 100A X 1/2" I.D. - 95 CoolBLAST	1/2"	1.10"	1.34"	95	1.85"	M10 x 1.5P
39315B	HSK 100A X 1/2" I.D. - 160 CoolBLAST	1/2"	1.10"	1.34"	160	1.85"	M10 x 1.5P
39318B	HSK 100A x 5/8" I.D. - 100mm CoolBLAST	5/8"	1.06"	1.34"	100	1.97"	M12 x 1.75P
39319B	HSK 100A x 5/8" I.D. - 160 CoolBLAST	5/8"	1.26"	1.34"	160	1.97"	M12 x 1.75P
39320B	HSK 100A x 3/4" I.D. - 105 CoolBLAST	3/4"	1.42"	1.65"	105	2.04"	M16 x 2.0P
39321B	HSK 100A x 3/4" I.D. - 160 CoolBLAST	3/4"	1.42"	1.65"	160	2.04"	M16 x 2.0P
39324B	HSK 100A x 1" I.D. - 115 CoolBLAST	1.0"	1.81"	2.09"	115	2.28"	M20 x 2.0P
39325B	HSK 100A x 1" I.D. - 160 CoolBLAST	1.0"	1.81"	2.09"	160	2.28"	M20 x 2.0P
39326B	HSK 100A x 1-1/4" I.D. - 120 CoolBLAST	1-1/4"	1.81"	2.09"	120	2.28"	M20 x 2.0P
39327B	HSK 100A x 1-1/4" - 160 CoolBLAST	1-1/4"	1.81"	2.09"	160	2.28"	M20 x 2.0P

NEW

SFS12 ShrinkFIT Holders & Adapters

SFS12 Shrink Adapters provide excellent accuracy and clearance at extended lengths. A great choice for mold & die applications.



- Great for fast tool changes using shrink adapters
- Balanced to 25,000 RPM @ G2.5 – T.I.R. only .0001"
- Powerful drawbar system is fast and easy to use

Bonus: SlimFIT 12 is compatible with other modular shrink fit systems!

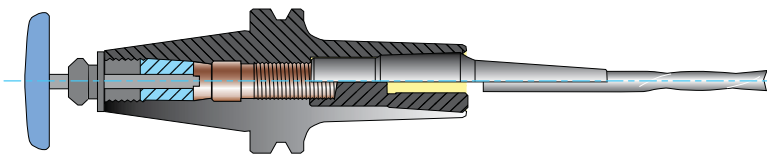

How It Works

SFS toolholders feature a powerful internal drawbar design for maximum holding power and accuracy. Use SlimFIT 12 shrink adapters with the SFS12 holders so you don't have to buy so many holders, just use adapters for your tool shanks. The slim design provides excellent nose clearance, great for mold & die applications.

Adapters fit inch size shanks: 1/8" up to 1/2"
Metric shanks: 3mm – 12mm. (see next page)

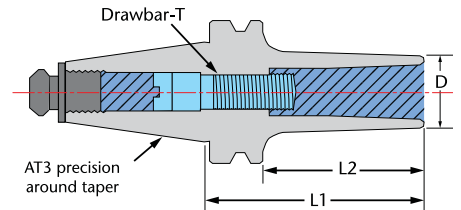

SFS12 HSK holders

Part No.	Description	L1	L2	D	Drawbar-T
99.780.12.075	HSK40E x SFS12 - 2.95"	2.95"	2.16"	1.50"	SFS-M10C-20.6
73.780.12.075	HSK63A x SFS12 - 2.95"	2.95"	1.85"	1.50"	SFS-M10C-20.6
103.780.12.065	HSK63F x SFS12 - 2.56"	2.56"	1.45"	1.50"	SFS-M10C-20.6
75.780.12.105	HSK100A x SFS12 - 4.13"	4.13"	1.85"	1.50"	SFS-M10C-20.6

SFS12 ShrinkFIT Adapters – Inch & Metric Size

Inch Size SFS Adapters

Part No.	Description	D	L	L1	D1	D2
258.SFS12.52.138	SFS 12 x 1/8" - 1.38"	1/8"	1.38"	.87"	.24"	.33"
258.SFS12.53.138	SFS 12 x 3/16" - 1.38"	3/16"	1.38"	.87"	.31"	.40"
258.SFS12.54.138	SFS 12 x 1/4" - 1.38"	1/4"	1.38"	.87"	.37"	.46"
258.SFS12.56.138	SFS 12 x 3/8" - 1.38"	3/8"	1.38"	.87"	.49"	.58"
258.SFS12.58.138	SFS 12 x 1/2" - 1.38"	1/2"	1.38"	.87"	.62"	.71"
258.SFS12.52.055	SFS 12 x 1/8" - 2.16"	1/8"	2.16"	1.65"	.24"	.41"
258.SFS12.52.055-3	SFS 12 x 1/8" - 2.16"	1/8"	2.16"	1.65"	.36"	.64"
258.SFS12.53.055	SFS 12 x 3/16" - 2.16"	3/16"	2.16"	1.65"	.30"	.48"
258.SFS12.54.055	SFS 12 x 1/4" - 2.16"	1/4"	2.16"	1.65"	.37"	.54"
258.SFS12.56.055	SFS 12 x 3/8" - 2.16"	3/8"	2.16"	1.65"	.49"	.66"
258.SFS12.58.055	SFS 12 x 1/2" - 2.16"	1/2"	2.16"	1.65"	.62"	.79"
258.SFS12.52.315	SFS 12 x 1/8" - 3.15"	1/8"	3.15"	2.64"	.24"	.52"
258.SFS12.53.315	SFS 12 x 3/16" - 3.15"	3/16"	3.15"	2.64"	.31"	.58"
258.SFS12.54.315	SFS 12 x 1/4" - 3.15"	1/4"	3.15"	2.64"	.37"	.64"
258.SFS12.56.315	SFS 12 x 3/8" - 3.15"	3/8"	3.15"	2.64"	.49"	.77"
258.SFS12.58.315	SFS 12 x 1/2" - 3.15"	1/2"	3.15"	2.64"	.62"	.89"
258.SFS12.52.433	SFS 12 x 1/8" - 4.33"	1/8"	4.33"	3.82"	.24"	.64"
258.SFS12.53.433	SFS 12 x 3/16" - 4.33"	3/16"	4.33"	3.82"	.31"	.71"
258.SFS12.54.433	SFS 12 x 1/4" - 4.33"	1/4"	4.33"	3.82"	.37"	.77"
258.SFS12.56.433	SFS 12 x 3/8" - 4.33"	3/8"	4.33"	3.82"	.49"	.89"
258.SFS12.58.433	SFS 12 x 1/2" - 4.33"	1/2"	4.33"	3.82"	.62"	1.02"

Metric Size SFS Adapters

Part No.	Description	D	L	L1	D1	D2
258.SFS12.03.035	SFS12 x 3mm - 35mm	3mm	35mm	22mm	6mm	8.3mm
258.SFS12.04.035	SFS12 x 4mm - 35mm	4mm	35mm	22mm	7mm	9.3mm
258.SFS12.06.035	SFS12 x 6mm - 35mm	6mm	35mm	22mm	9mm	11.3mm
258.SFS12.08.035	SFS12 x 8mm - 35mm	8mm	35mm	22mm	11mm	13.3mm
258.SFS12.10.035	SFS12 x 10mm - 35mm	10mm	35mm	22mm	13mm	15.3mm
258.SFS12.12.035	SFS12 x 12mm - 35mm	12mm	35mm	22mm	15mm	17.3mm
258.SFS12.03.055	SFS12 x 3mm - 55mm	3mm	55mm	42mm	6mm	10.4mm
258.SFS12.04.055	SFS12 x 4mm - 55mm	4mm	55mm	42mm	7mm	11.4mm
258.SFS12.06.055	SFS12 x 6mm - 55mm	6mm	55mm	42mm	9mm	13.4mm
258.SFS12.08.055	SFS12 x 8mm - 55mm	8mm	55mm	42mm	11mm	15.4mm
258.SFS12.10.055	SFS12 x 10mm - 55mm	10mm	55mm	42mm	13mm	17.4mm
258.SFS12.12.055	SFS12 x 12mm - 55mm	12mm	55mm	42mm	15mm	19.4mm
258.SFS12.03.080	SFS12 x 3mm - 80mm	3mm	80mm	67mm	6mm	13mm
258.SFS12.04.080	SFS12 x 4mm - 80mm	4mm	80mm	67mm	7mm	14mm
258.SFS12.06.080	SFS12 x 6mm - 80mm	6mm	80mm	67mm	9mm	16.2mm
258.SFS12.08.080	SFS12 x 8mm - 80mm	8mm	80mm	67mm	11mm	18mm
258.SFS12.10.080	SFS12 x 10mm - 80mm	10mm	80mm	67mm	13mm	20mm
258.SFS12.03.110	SFS12 x 3mm - 110mm	3mm	110mm	97mm	6mm	16.2mm
258.SFS12.04.110	SFS12 x 4mm - 110mm	4mm	110mm	97mm	7mm	17.2mm
258.SFS12.06.110	SFS12 x 6mm - 110mm	6mm	110mm	97mm	9mm	19.2mm
258.SFS12.08.110	SFS12 x 8mm - 110mm	8mm	110mm	97mm	11mm	21.2mm
258.SFS12.10.110	SFS12 x 10mm - 110mm	10mm	110mm	97mm	13mm	23.1mm
258.SFS12.12.110	SFS12 x 12mm - 110mm	12mm	110mm	97mm	15mm	25.2mm

NEW

High Precision HSK Hydraulic Holders



Features

- Balanced to 25,000 RPM at G2.5
- T.I.R. 0.0001" measured at 3X shank diameter
- Taper precision ground to AT3 standard
- AD coolant-thru is standard

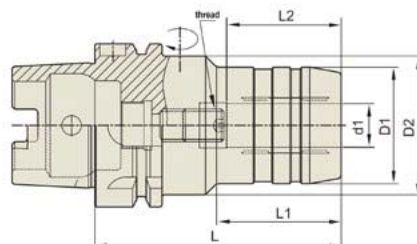

HSK63A Hydraulic Toolholders – Inch and Metric

Part No.	Description	d1	D1	D2	L	L1	L2	Thread
157250	HSK63A-HC 1/4-70 Hydro	1/4"	1.024"	1.969"	2.756"	0.945"	1.063"	M5x0.8
157500	HSK63A-HC 1/2-85 Hydro	1/2"	1.260"	1.969"	3.346"	1.575"	1.457"	M10x1.0
157750	HSK63A-HC 3/4-90 Hydro	3/4"	1.654"	1.969"	3.543"	1.890"	1.654"	M16x1.0
157100	HSK63A-HC 1-4.72 Hydro	1.0"	2.244"	2.480"	4.724"	2.323"	1.890"	M16x1.0
157125	HSK63A-HC 1.1/4-4.92 Hydro	1 1/4"	2.520"	2.953"	4.921"	2.480"	2.165"	M16x1.0
157060	HSK63A-HC 6-70 Hydro	6mm	26mm	50mm	70mm	24mm	27mm	M5x0.8
157080	HSK63A-HC 8-70 Hydro	8mm	28mm	50mm	70mm	25mm	27mm	M6x1.0
157010	HSK63A-HC 10-80 Hydro	10mm	30mm	50mm	80mm	35mm	32mm	M8x1.0
157012	HSK63A-HC 12-85 Hydro	12mm	32mm	50mm	85mm	-	37mm	M10x1.0
157014	HSK63A-HC 14-85 Hydro	14mm	34mm	50mm	85mm	40mm	37mm	M10x1.0
157016	HSK63A-HC 16-90 Hydro	16mm	38mm	50mm	90mm	46mm	42mm	M12x1.0
157018	HSK63A-HC 18-90 Hydro	18mm	40mm	50mm	90mm	47mm	42mm	M12x1.0
157200	HSK63A-HC 20-80 Hydro	20mm	53mm	53mm	80mm	-	42mm	M16x1.0
157020	HSK63A-HC 20-90 Hydro	20mm	42mm	50mm	90mm	48mm	42mm	M16x1.0
157025	HSK63A-HC 25-120 Hydro	25mm	57mm	63mm	120mm	54.5mm	48mm	M16x1.0
157032	HSK63A-HC 32-125 Hydro	32mm	64mm	75mm	125mm	63mm	55mm	M16x1.0

HSK63A-HMC Hydraulic Toolholders – Inch

Part No.	Description	d1	D1	D2	L	L1	L2	Thread
158250	HSK63A-HMC 1/4"-5.71 Hydro	1/4"	0.787"	1.969"	5.709"	3.543"	1.063"	M5x0.8
158312	HSK63A-HMC 5/16"-5.71 Hydro	5/16"	0.866"	1.969"	5.709"	3.543"	1.063"	M6x1.0
158375	HSK63A-HMC 3/8"-5.71 Hydro	3/8"	0.945"	1.969"	5.709"	3.543"	1.260"	M8x1.0
158500	HSK63A-HMC 1/2"-5.71 Hydro	1/2"	1.024"	1.969"	5.709"	3.543"	1.457"	M10x1.0
158625	HSK63A-HMC 5/8"-5.7 Hydro	5/8"	1.260"	1.969"	5.709"	3.543"	1.654"	M12x1.0
158750	HSK63A-HMC 3/4"-5.7 Hydro	3/4"	1.339"	1.969"	5.709"	3.543"	1.654"	M16x1.0

HSK63F Hydraulic Toolholders – Inch Size

Part No.	Description	d1	D1	D2	L	L1	L2	Thread
160750	HSK63F-HC 3/4-85 Hydro	3/4"	1.654"	1.969"	3.346"	1.693"	1.654"	M16x1.0
160100	HSK63F-HC 1-120 Hydro	1.0"	2.244"	2.480"	4.724"	2.323"	1.575"	M16x1.0

HSK100A Hydraulic Toolholders – Inch and Metric

Part No.	Description	d1	D1	D2	L	L1	L2	Thread
159250	HSK100A-HC 1/4-75 Hydro	1/4"	1.024"	1.969"	2.953"	1.024"	1.063"	M5x0.8
159375	HSK100A-HC 3/8-90 Hydro	3/8"	1.181"	1.969"	3.543"	1.654"	1.260"	M8x1.0
159500	HSK100A-HC 1/2-95 Hydro	1/2"	1.260"	1.969"	3.740"	1.850"	1.457"	M10x1.0
159750	HSK100A-HC 3/4-105 Hydro	3/4"	1.654"	4.134"	2.323"	1.654"	1.654"	M16x1.0
159100	HSK100A-HC 1-110 Hydro	1.0"	2.244"	2.480"	4.331"	2.441"	1.890"	M16x1.0
159125	HSK100A-HC 31 1/4-110 Hydro	1 1/4"	2.520"	2.953"	4.331"	2.441"	2.165"	M16x1.0
159200	HSK100A-HC 20S-90 Hydro	20mm	53mm	53mm	90mm	-	42mm	M16x1.0



High Precision HSK End Mill Holders



HSK63A

Features

- I.D. bore tolerance is H5
- Balanced to 15,000 RPM at G6.3
- Taper ground to AT3 tolerance



Technics Certified for bore and taper tolerances

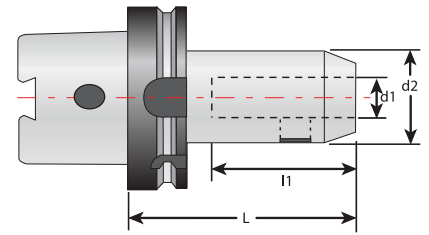

HSK63A End Mill Holders

Part No.	Description - I.D.	d1	d2	L	l1
NEW 32946	HSK63A x End Mill holder 1/8"	1/8"	.68"	3"	.79"
NEW 32946-5	HSK63A x End Mill holder 1/8"	1/8"	.68"	5"	.79"
NEW 32947	HSK63A x End Mill holder 3/16"	3/16"	.68"	3"	1.0"
NEW 32947-5	HSK63A x End Mill holder 3/16"	3/16"	.68"	5"	1.0"
NEW 32948	HSK63A x End Mill holder 1/4"	1/4"	.78"	3"	1.38"
NEW 32948-5	HSK63A x End Mill holder 1/4"	1/4"	.78"	5"	1.38"
NEW 32952	HSK63A x End Mill holder 3/8"	3/8"	1.0"	3"	1.54"
NEW 32952-5	HSK63A x End Mill holder 3/8"	3/8"	1.0"	5"	1.54"
NEW 32954	HSK63A x End Mill holder 1/2"	1/2"	1.38"	3"	1.97"
NEW 32954-5	HSK63A x End Mill holder 1/2"	1/2"	1.38"	5"	1.97"
NEW 32956	HSK63A x End Mill holder 5/8"	5/8"	1.63"	3.75"	2.09"
NEW 32956-5	HSK63A x End Mill holder 5/8"	5/8"	1.63"	5"	2.09"
NEW 32958	HSK63A x End Mill holder 3/4"	3/4"	1.75"	3.75"	2.22"
NEW 32958-6	HSK63A x End Mill holder 3/4"	3/4"	1.75"	6"	2.22"
NEW 32962	HSK63A x End Mill holder 1.0"	1.0"	2.00"	3.75"	2.46"
NEW 32964	HSK63A x End Mill holder 1-1/4"	1-1/4"	2.50"	4.25"	2.51"

HSK63F Side Lock End Mill Holders

Part No.	Description - I.D.	d1	d2	L	l1
NEW 32958-4-F	HSK63F x SLN 3/4" - 4.0"	3/4"	1.75"	4.0"	4.0"
NEW 32962-4-F	HSK63F x SLN 1" - 4.0"	1"	2"	4.0"	4.0"
NEW 32838-4-F	HSK63F x SLN 25mm - 4.0"	25mm	65mm	4.0"	4.0"
NEW 32840-4-F	HSK63F x SLN 32mm - 4.0"	32mm	72mm	4.0"	4.0"
NEW 32840-F	HSK63F x SLN 32mm - 110mm	32mm	72mm	110mm	4.0"

HSK100A End Mill Holders

Part No.	Description - I.D.	d1	d2	L	l1
32984	HSK100A x End Mill holder 1/2"	1/2"	1.38"	3.25"	1.97"
32986	HSK100A x End Mill holder 5/8"	5/8"	1.63"	3.75"	2.09"
32988	HSK100A x End Mill holder 3/4"	3/4"	1.75"	3.75"	2.22"
32992	HSK100A x End Mill holder 1"	1"	2.00"	4.25"	2.46"
32994	HSK100A x End Mill holder 1-1/4"	1-1/4"	2.50"	4.25"	2.51"
32996	HSK100A x End Mill holder 1-1/2"	1-1/2"	2.75"	4.50"	2.93"
32998	HSK100A x End Mill holder 2"	2"	3.75"	5.50"	3.53"

High Precision HSK Face Mill Arbors



All Techniks Face Mill Arbors come with the solid arbor screw and key listed.

Features

- Compatible with all face mills
- H6 arbor tolerance for less chatter & better tool life
- Taper ground to AT3 tolerance or better

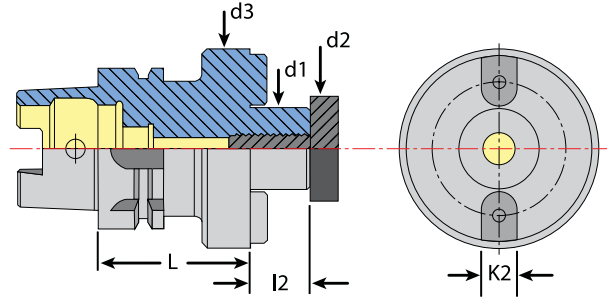

HSK63A Face Mill Arbors Standard and Extended Lengths

Part No.	Description	L	l2	d1	d2	d3	K2	Screw	Key
93500	HSK63A x FMA 3/4" - 2"	2"	.687"	.75"	.875"	1.69"	.313"	WF0.75	FMAKEY-3/4
NEW 93510	HSK63A x FMA 3/4" - 4"	4"	.687"	.75"	.875"	1.69"	.313"	WF0.75	FMAKEY-3/4
93510-8	HSK63A x FMA 3/4" - 8"	8"	.687"	.75"	.875"	1.69"	.313"	WF0.75	FMAKEY-3/4
93501	HSK63A x FMA 1.0" - 2.37"	2.37"	.687"	1.0"	1.24"	2.2"	.375"	WF1	FMAKEY-1
NEW 93520	HSK63A x FMA 1.0" - 4"	4"	.687"	1.0"	1.24"	2.2"	.375"	WF1	FMAKEY-1
NEW 93520-6	HSK63A x FMA 1.0" - 6"	6"	.687"	1.0"	1.24"	2.2"	.375"	WF1	FMAKEY-1
NEW 93520-8	HSK63A x FMA 1.0" - 8"	8"	.687"	1.0"	1.24"	2.2"	.375"	WF1	FMAKEY-1
93502	HSK63A x FMA 1-1/4" - 2.75"	2.75"	.687"	1.25"	1.5"	2.75"	.5"	WF1.25	FMAKEY-1-1/4
93530	HSK63A x FMA 1-1/4" - 4"	4"	.687"	1.25"	1.5"	2.75"	.5"	WF1.25	FMAKEY-1-1/4
NEW 93530-6	HSK63A x FMA 1-1/4" - 6"	6"	.687"	1.25"	1.5"	2.75"	.5"	WF1.25	FMAKEY-1-1/4
NEW 93530-8	HSK63A x FMA 1-1/4" - 8"	8"	.687"	1.25"	1.5"	2.75"	.5"	WF1.25	FMAKEY-1-1/4
NEW 93550	HSK63A x FMA 1-1/2" - 4"	4"	.94"	1.5"	1.88"	3.8"	.63"	WF1.5	FMAKEY-1-1/2

HSK63F Face Mill Arbors

Part No.	Description - I.D.	L	l2	d1	d2	d3	K2	Screw	Key
NEW 93510-F	HSK63F x FMA 3/4" - 4.0"	4.0"	.69"	3/4"	.88"	1.69"	.31"	WF0.75	FMAKEY-3/4
NEW 93520-F	HSK63F x FMA 1" - 4.0"	4.0"	.69"	1.0"	1.19"	2.20"	.38"	WF1	FMAKEY-1
NEW 93530-F	HSK63F x FMA 1-1/4" - 4.0"	4.0"	.69"	1-1/4"	1.50"	2.75"	.50"	WF1.25	FMAKEY-1-1/4
NEW 93550-F	HSK63F x FMA 1-1/2" - 4.0"	4.0"	.94"	1-1/2"	1.88"	3.80"	.63"	WF1.5	FMAKEY-1-1/2

HSK100A Face Mill Arbors

Part No.	Description	L	l2	d1	d2	d3	K2	Screw	Key
95901	HSK100A x FMA 3/4" - 2"	2"	.69"	.75"	.88"	1.69"	.31"	WF0.75	FMAKEY-3/4
NEW 95901-6	HSK100A x FMA 3/4" - 6"	6"	.69"	.75"	.88"	1.69"	.31"	WF0.75	FMAKEY-3/4
95903	HSK100A x FMA 1.0" - 2"	2"	.69"	1.0"	1.19"	2.2"	.38"	WF1	FMAKEY-1
NEW 95903-6	HSK100A x FMA 1.0" - 6"	6"	.69"	1.0"	1.19"	2.2"	.38"	WF1	FMAKEY-1
95905	HSK100A x FMA 1-1/4" - 2.5"	2.5"	.69"	1.25"	1.5"	2.75"	.5"	WF1.25	FMAKEY-1-1/4
NEW 95905-6	HSK100A x FMA 1-1/4" - 6"	6"	.69"	1.25"	1.5"	2.75"	.5"	WF1.25	FMAKEY-1-1/4
95907	HSK100A x FMA 1-1/2" - 2.5"	2.5"	.94"	1.5"	1.88"	3.8"	.63"	WF1.5	FMAKEY-1-1/2
NEW 95907-6	HSK100A x FMA 1-1/2" - 6"	6"	.94"	1.5"	1.88"	3.8"	.63"	WF1.5	FMAKEY-1-1/2

HSK63A Precision SlimFIT SBL6 Holders



Techniks Certified for accuracy and balance

Features

- Maximum T.I.R. 0.0001" from taper to collet pocket
- Balanced to 25,000 RPM at G2.5
- .55" nose diameters

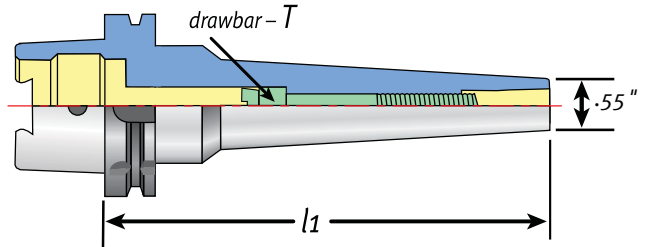

SlimFIT SBL6 holders feature 4° collets and a powerful drawbar tightening system that hold tools tighter and more accurately at extended lengths than ER systems. For tools 3/32" up to 1/4" (3mm-6mm).

Tool changes do not require tightening fixtures, or torque wrenches and can be performance by hand, using the supplied T-wrench.

HSK63A SlimFIT Toolholders

Part No.	Description	l1	l2	Drawbar-T
35470	HSK63A x SBL6-80 SlimFIT	80mm	54mm	SYIC-SBL-M6C-15
35472	HSK63A x SBL6-120 SlimFIT	120mm	94mm	SYIC-SBL-M6C-50

Replacement T20 Wrenches

Part No.	Description
T2050TKIA81F	100mm T-Handle
T20L3TKIA81F	200mm slim shaft fits coolant pull stud



SlimFIT Inch Collets

Part No.	Description
18851-3/32	SlimFIT 6 - 3/32" collet
18851-7/64	SlimFIT 6 - 7/64" collet
18851-1/8	SlimFIT 6 - 1/8" collet
18851-9/64	SlimFIT 6 - 9/64" collet
18851-5/32	SlimFIT 6 - 5/32" collet
18851-11/64	SlimFIT 6 - 11/64" collet
18851-3/16	SlimFIT 6 - 3/16" collet
18851-13/64	SlimFIT 6 - 13/64" collet
18851-7/32	SlimFIT 6 - 7/32" collet
18851-15/64	SlimFIT 6 - 15/64" collet
18851-1/4	SlimFIT 6 - 1/4" collet



SlimFIT Inch & Metric Set

Part No.	Description
18851-12IMS	SlimFIT 12 piece set

Convenient collet set provides the collets you need, and the wooden tray prevents damage to collets.

Set includes 12 collets:

INCH: 7/64", 1/8", 9/64", 11/64", 3/16", 13/64", 15/64", 1/4"

METRIC: 3mm, 4mm, 5mm, 6mm



SlimFIT Metric Collets

Part No.	Description
18851-03	SlimFIT 6 - 3mm collet
18851-04	SlimFIT 6 - 4mm collet
18851-05	SlimFIT 6 - 5mm collet
18851-05.5	SlimFIT 6 - 5.5mm collet
18851-06	SlimFIT 6 - 6mm collet

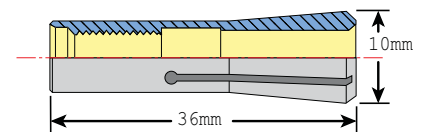

SlimFIT Collet Dimensions

NOTE: Tighten to 9 ft/lbs

MicroFLOAT, Tension/Compression, & Rigid Tapping Holders



MicroFLOAT synchronous feed holders is the recommended solution for improving rigid tapping performance and extending tap life.

MicroFLOAT cushion the sudden shocks taps are subject to during the tapping cycle.

During the tapping cycle MicroFLOAT's synchronous feed technology automatically corrects for mechanical variances such as ballscrew play, spindle wear, or material irregularities to produce the truest possible threads. [Click to Learn More.](#)

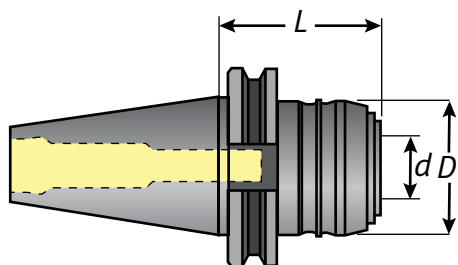

MicroFLOAT Synchronous Rigid Tap holders

Part No.	Description	L	D	d
23400-H63A	HSK63A holder #1	2.52"	1.7"	.79"



Tension / Compression Tap Holders

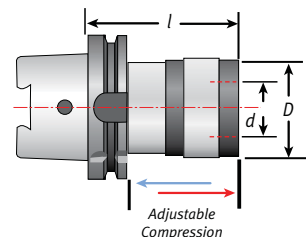

Part No.	Description	d	D	l	Size	Tap Capacity	Compensation	
							Tension	Compression
34400/H40A	HSK40A T/C Holder, Size 1	0.748"	1.5"	3.14"	1	0 - 9/16"	0.295"	0.295"
34400/H50A	HSK50A T/C Holder, Size 1	0.748"	1.5"	2.83"	1	0 - 9/16"	0.295"	0.295"
34400/H63A	HSK63A T/C Holder, Size 1	0.748"	1.5"	2.83"	1	0 - 9/16"	0.295"	0.295"
34400/H100A	HSK100A T/C Holder, Size 1	0.748"	1.5"	3.14"	1	0 - 9/16"	0.295"	0.295"
34600/H50A	HSK50A T/C Holder, Size 2	1.22"	2.17"	4.33"	2	5/16 - 7/8"	0.393"	0.393"
34600/H63A	HSK63A T/C Holder, Size 2	1.22"	2.17"	4.33"	2	5/16 - 7/8"	0.393"	0.393"
34600/H100A	HSK100A T/C Holder, Size 2	1.22"	2.17"	3.94"	2	5/16 - 7/8"	0.393"	0.393"



Rigid Tap Holders

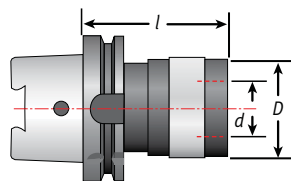

Part No.	Description	l	D	d	Size	Tap Capacity
21480/H50A	HSK50A Rigid Tap Holder, Size 1	2.30"	1.31"	0.748"	1	0 - 9/16"
21480/H63A	HSK63A Rigid Tap Holder, Size 1	2.32"	1.31"	0.748"	1	0 - 9/16"
21480/H100A	HSK100A Rigid Tap Holder, Size 1	2.95"	1.31"	0.748"	1	0 - 9/16"
21680/H50A	HSK50A Rigid Tap Holder, Size 2	3.23"	1.97"	1.22"	2	5/16 - 7/8"
21680/H63A	HSK63A Rigid Tap Holder, Size 2	3.23"	1.97"	1.22"	2	5/16 - 7/8"
21680/H100A	HSK100A Rigid Tap Holder, Size 2	3.86"	1.97"	1.22"	2	5/16 - 7/8"
21880/H63A	HSK63A Rigid Tap Holder, Size 3	4.80"	2.83"	1.89"	3	1/2 - 1 3/8"
21880/H100A	HSK100A Rigid Tap Holder, Size 3	4.80"	2.83"	1.89"	3	1/2 - 1 3/8"

HSK63A/100A Milling Chucks



Features

- Grips shank up to 5x tighter than ER 40 holders
- Nut seats against the flange when properly tightened (prevents overtightening)
- CoolBLAST coolant-thru standard on all milling chucks

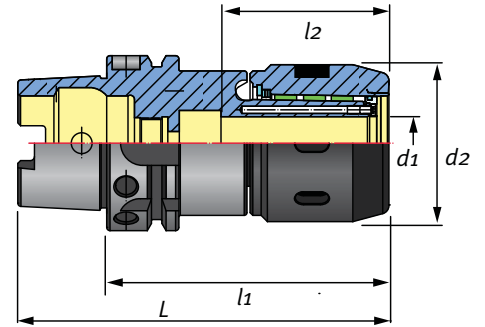

Each Techniks High-Performance Milling Chuck is inspected, tested, and certified for quality, accuracy, and holding power. A full lab report is included with each holder.

HSK63A and HSK100A Milling Chucks

Part No.	Description	L	l1	l2	d1	d2	Holding Power
33232G	HSK63A X MLD 3/4" - 4"	5.30"	4"	2.01"	.75"	2.22"	350 ft/lbs
33236G	HSK63A x MLD 1-1/4" - 4.72"	5.98"	4.72"	2.65"	1.25"	2.80"	500 ft/lbs
33252G	HSK100A X MLD 3/4" - 4.72"	6.70"	4.72"	2.01"	.75"	2.22"	350 ft/lbs
33256G	HSK100A x MLD 1-1/4" - 4.72"	6.70"	4.72"	2.65"	1.25"	2.79"	500 ft/lbs



Tool+Cutter
Specialists in Cutting Tools Since 1969

LONDON
T 519-681-5600
F 519-681-8688
 1-800-265-6056

NIAGARA
T 905-684-6571
F 905-684-2286
 1-800-567-0617

WOODSTOCK
T 519-421-9730
F 519-421-9285
 1-800-565-2603

www.toolandcutter.com